



SCHEDA TECNICA

TECHNICAL FEATURES

ART. COD.

N 40

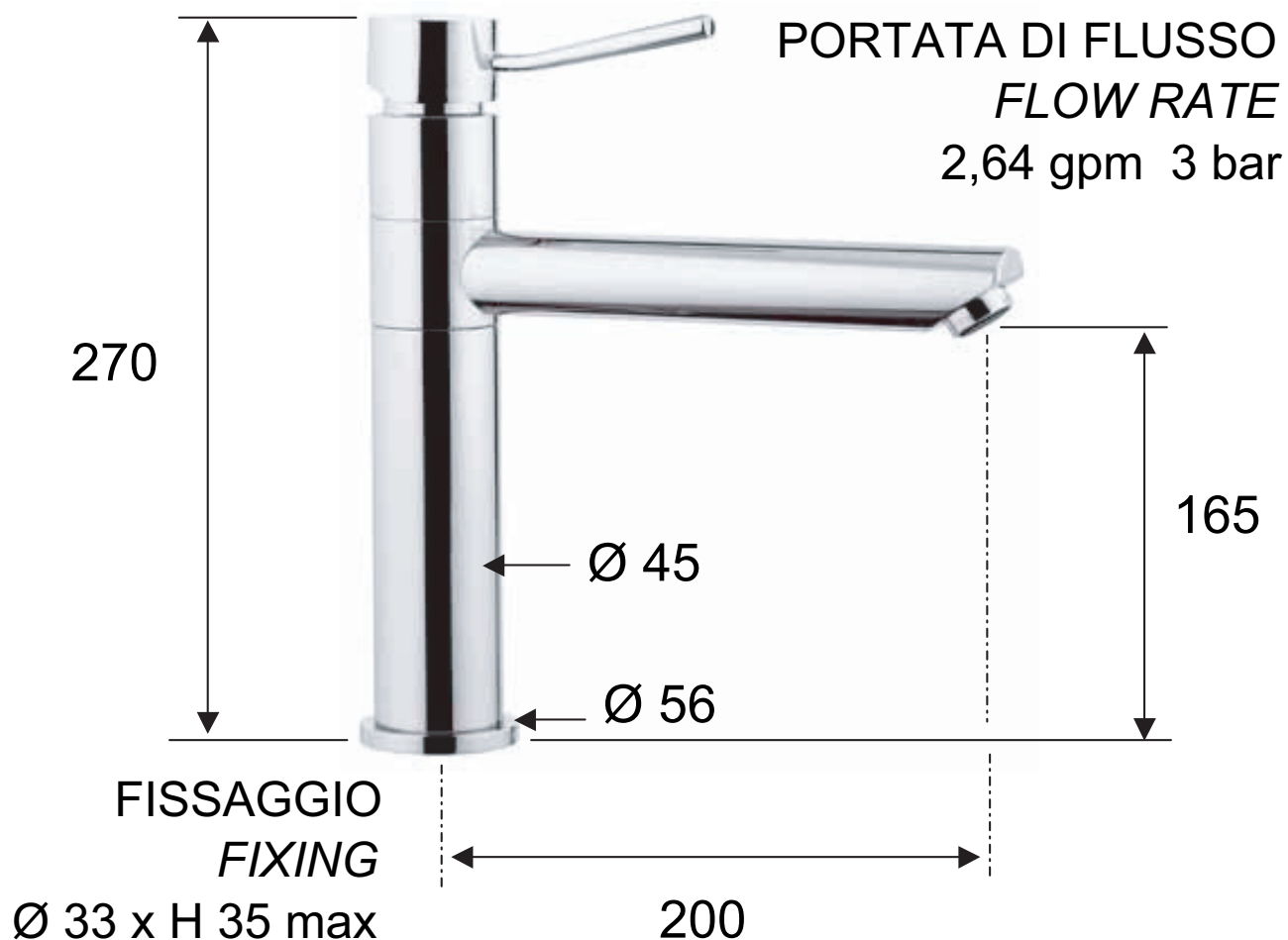

MATERIALI / MATERIALS

OTTONE CROMATO / CHROME PLATED BRASS

CROMATURA / CHROME PLATING

UNI EN 248

Via Leonardo da Vinci 83 - 20062 Cassano d'Adda (MI) Italy - Tel. +39-0363 364211

info@remer.eu www.remer.eu